

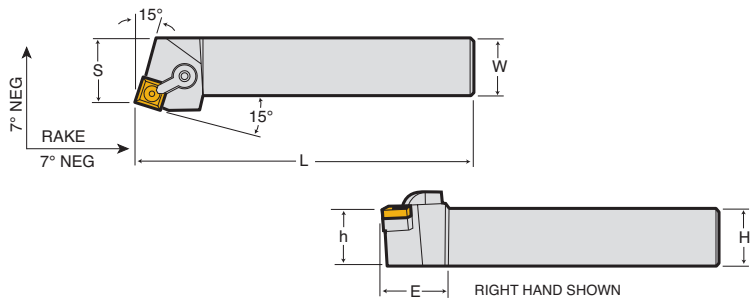

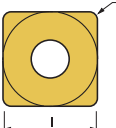

MSRNR/L





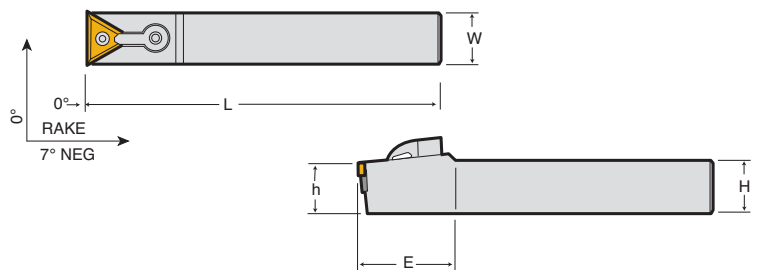

Ref	Holder Style				Application						Inserts	Parts			
Comment	R Style, Approach Angle 75°				Turning										
MSRNR/L	Code #		Code #		H	W	L	S	h	E					
	Right	Price \$	Left	Price \$											
12-4B	145869	99.01	145870	99.01	0.750	0.750	4.500	0.878	0.750	1.230	SN □ □ 43 □	CL-12	XNS-48	ISSN-432	NL-46
16-4D	145800	222.45	145801	222.45	1.000	1.000	6.000	1.128	1.000	1.230		146917	146922	146903	146912
20-5D	145802	267.05	145803	184.44	1.250	1.250	6.000	1.350	1.250	1.375	SN □ □ 54 □	CL-12	XNS-59	ISSN-533	NL-58
20-6D	145804	267.05	145805	267.05	1.250	1.250	6.000	1.318	1.250	1.500	SN □ □ 64 □	CL-12	XNS-510	ISSN-633	NL-68
24-6E	145806	314.24	145807	314.24	1.500	1.500	7.000	1.818	1.500	1.500		146917	146920	146905	146914
												146917	146920	146905	146914

► P. E19-22, E38, E40

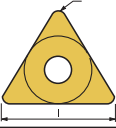
MTCNN



Ref	Holder Style			Application						Inserts	Parts			
Comment	C Style			Turning										
MTCNN	Code #	Price \$	H	W	L	h	E	Clamp	Clamp Screw					
12-4B	145859	264.75	0.750	0.750	4.500	0.750	1.430	TN □ □ 43 □	CL-12	XNS-59	ITSN-432	NL-46		
									146917	146921	146901	146912		
									\$ 10.00	\$ 2.38	\$ 12.05	\$ 5.04		

► P. E24-27, E41