

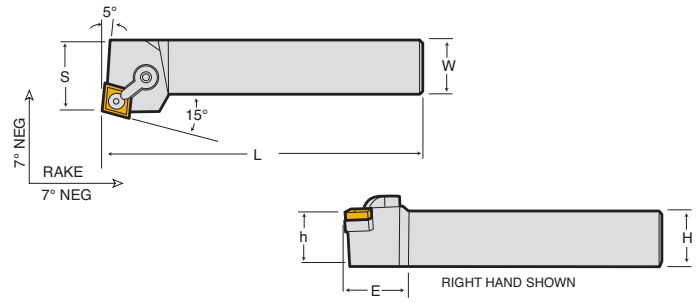

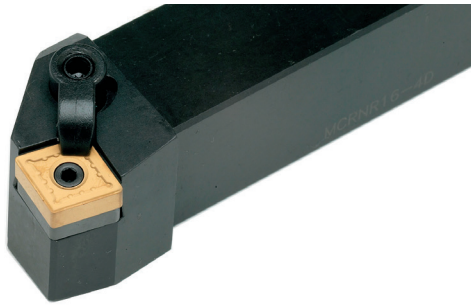

## MCRNR/L

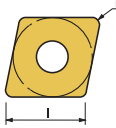



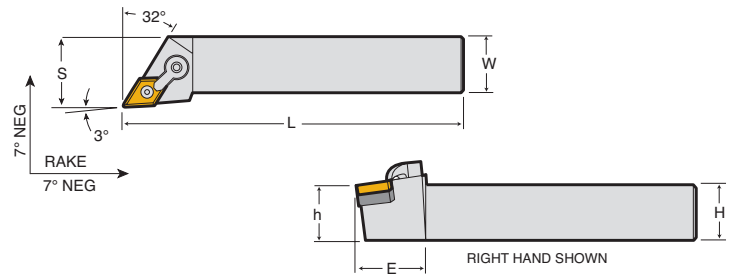

| Ref     | Holder Style                |          |        |          | Application     |       |       |      |       |      | Inserts  | Parts   |   |   |   |
|---------|-----------------------------|----------|--------|----------|-----------------|-------|-------|------|-------|------|--|---|---|---|---|
| Comment | R Style, Approach Angle 75° |          |        |          | Turning, Facing |       |       |      |       |      |  |  |  |  |  |
| MCRNR/L | Code #                      |          | Code # |          | H               | W     | L     | S    | h     | E    |  |   |   |   |   |
|         | Right                       | Price \$ | Left   | Price \$ |                 |       |       |      |       |      |  |   |   |   |   |
| 16-4D   | 145835                      | 163.38   | 145836 | 163.38   | 1.000           | 1.000 | 6.000 | 1.25 | 1.000 | 1.24 | CN □ □ 43 □  | CL-20   | XNS-48  | ICSN-432  | NL-46   |
| 20-4D   | 145837                      | 194.27   | 145778 | 199.77   | 1.250           | 1.250 | 6.000 | 1.50 | 1.250 | 1.24 |  | 146918<br>\$ 7.35   | 146922<br>\$ 1.66   | 146908<br>\$ 8.04   | 146912<br>\$ 3.63   |
| 20-5D   | 145839                      | 196.13   | 145840 | 196.13   | 1.250           | 1.250 | 6.000 | 1.50 | 1.250 | 1.34 | CN □ □ 54 □  | CL-12   | XNS-510   | ICSN-533  | NL-58   |
| 20-6D   | 145841                      | 196.13   | 145842 | 144.69   | 1.250           | 1.250 | 6.000 | 1.25 | 1.250 | 1.24 |  | 146917<br>\$ 7.35   | 146920<br>\$ 1.75   | 146909<br>\$ 9.96   | 146913<br>\$ 4.13   |
| 24-6E   | 145843                      | 230.79   | 145844 | 110.00   | 1.500           | 1.500 | 7.000 | 2.00 | 1.500 | 1.49 | CN □ □ 64 □  | CL-12   | XNS-510   | ICSN-633  | NL-68   |
|         |                             |          |        |          |                 |       |       |      |       |      |  | 146917<br>\$ 7.35   | 146920<br>\$ 1.75   | 146910<br>\$ 11.52  | 146914<br>\$ 4.62   |

► P. E10-12, E39

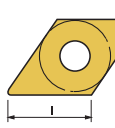
## MDJNR/L



| Ref     | Holder Style                |          |        |          | Application      |       |       |       |       |       | Inserts   | Parts   |   |   |   |
|---------|-----------------------------|----------|--------|----------|------------------|-------|-------|-------|-------|-------|---|---|---|---|---|
| Comment | J Style, Approach Angle 93° |          |        |          | Turning, Copying |       |       |       |       |       |  |  |  |  |  |
| MDJNR/L | Code #                      |          | Code # |          | H                | W     | L     | S     | h     | E     |   |   |   |   |   |
|         | Right                       | Price \$ | Left   | Price \$ |                  |       |       |       |       |       |   |   |   |   |   |
| 12-4B   | 146328                      | 144.84   | 146330 | 144.84   | 0.750            | 0.750 | 4.500 | 1.000 | 0.750 | 1.200 | DN □ □ 44 □   | CL-12   | XNS-59  | IDSN-432  | NL-46   |
| 16-4D   | 145845                      | 175.29   | 145846 | 159.51   | 1.000            | 1.000 | 6.000 | 1.250 | 1.000 | 1.250 |   | 146917<br>\$ 7.35   | 146921<br>\$ 1.75   | 146907<br>\$ 7.35   | 146912<br>\$ 3.63   |
| 20-4D   | 145847                      | 196.13   | 145848 | 196.13   | 1.250            | 1.250 | 6.000 | 1.500 | 1.250 | 1.240 |   |   |   |   |   |

► P. E14-16, E38-40