

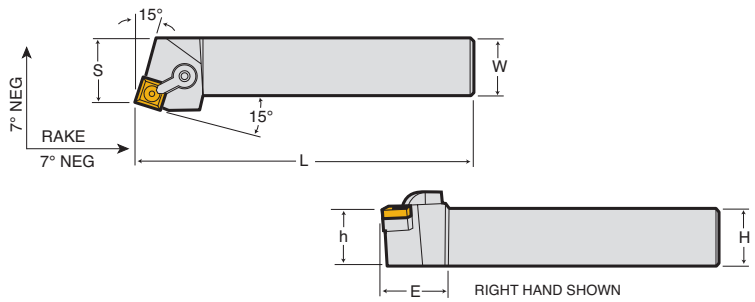

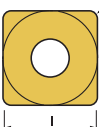

MSRNR/L





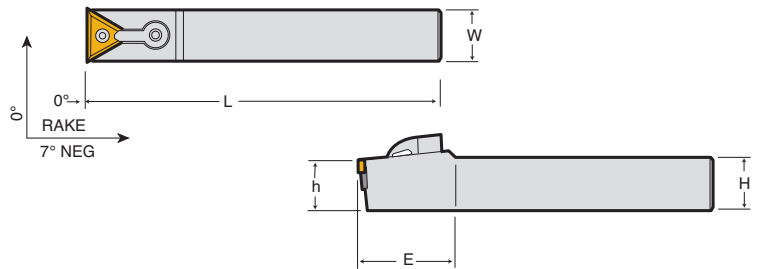

| Ref | Holder Style | | Application | | Inserts | | | | | | Parts | | | | |
|---------|-----------------------------|----------|-------------|----------|---------|-------|-------|-------|-------|-------|---|---|---|---|---|
| Comment | R Style, Approach Angle 75° | | Turning | | Turning | | | | | | Turning | | | | |
| MSRNR/L | Code # | | Code # | | H | W | L | S | h | E |  |  |  |  |  |
| | Right | Price \$ | Left | Price \$ | | | | | | | | | | | |
| 12-4B | 145869 | 72.72 | 145870 | 72.72 | 0.750 | 0.750 | 4.500 | 0.878 | 0.750 | 1.230 | SN □ □ 43 □ | CL-12 146917 \$ 7.35 | XNS-48 146922 \$ 1.66 | ISSN-432 146903 \$ 7.93 | NL-46 146912 \$ 3.63 |
| 16-4D | 145800 | 163.38 | 145801 | 163.38 | 1.000 | 1.000 | 6.000 | 1.128 | 1.000 | 1.230 | SN □ □ 43 □ | CL-12 146917 \$ 7.35 | XNS-59 146921 \$ 1.75 | ISSN-533 146904 \$ 8.98 | NL-58 146913 \$ 4.13 |
| 20-5D | 145802 | 196.13 | 145803 | 143.05 | 1.250 | 1.250 | 6.000 | 1.350 | 1.250 | 1.375 | SN □ □ 54 □ | CL-12 146917 \$ 7.35 | XNS-59 146921 \$ 1.75 | ISSN-533 146904 \$ 8.98 | NL-58 146913 \$ 4.13 |
| 20-6D | 145804 | 196.13 | 145805 | 196.13 | 1.250 | 1.250 | 6.000 | 1.318 | 1.250 | 1.500 | SN □ □ 64 □ | CL-12 146917 \$ 7.35 | XNS-510 146920 \$ 1.75 | ISSN-633 146905 \$ 11.78 | NL-68 146914 \$ 4.62 |
| 24-6E | 145806 | 230.79 | 145807 | 230.79 | 1.500 | 1.500 | 7.000 | 1.818 | 1.500 | 1.500 | | CL-12 146917 \$ 7.35 | XNS-510 146920 \$ 1.75 | ISSN-633 146905 \$ 11.78 | NL-68 146914 \$ 4.62 |

► P. E19-22, E38, E40

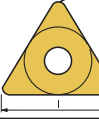
MTCNN



| Ref | Holder Style | | Application | | Inserts | | | | | | Parts | | | |
|---------|--------------|----------|-------------|----------|---------|-------|-------|-------|-------|---|---|---|---|---|
| Comment | C Style | | Turning | | Turning | | | | | | Turning | | | |
| MTCNN | Code # | | Code # | | H | W | L | h | E |  |  |  |  |  |
| | Code # | Price \$ | Code # | Price \$ | | | | | | | | | | |
| 12-4B | 145859 | 194.44 | | | 0.750 | 0.750 | 4.500 | 0.750 | 1.430 | TN □ □ 43 □ | CL-12 146917 \$ 7.35 | XNS-59 146921 \$ 1.75 | ITSN-432 146901 \$ 8.68 | NL-46 146912 \$ 3.63 |

► P. E24-27, E41